

version .0

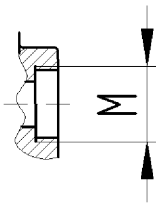
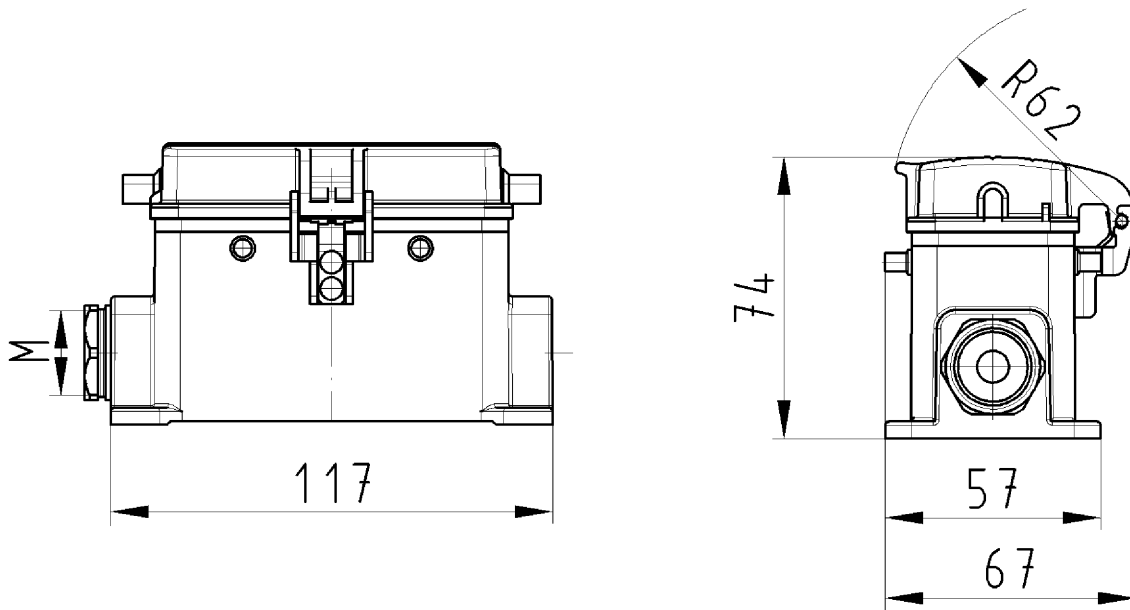

version .1

Gehäuseunterteil  
70.342.1635.0  
72.342.1635.0

Zeichnungsnummer  
70.342.1635.010W  
Gehäuseunterteil

22.11.2007  
Roppelt Dominik  
M 1:2